



# 8276H SMALL SYSTEM CRT CONTROLLER

- Programmable Screen and Character Format
- 6 Independent Visual Field Attributes
- Cursor Control (4 Types)
- MCS-51®, MCS-85®, iAPX 86, and iAPX 88 Compatible
- Dual Row Buffers
- Single +5V Supply
- 40-Pin Package
- 3 MHz Clock with 8276-2
- High Performance HMOS-II

The Intel 8276H Small System CRT Controller is a single chip device intended to interface CRT raster scan displays with Intel microcomputers in minimum device-count systems. Its primary function is to refresh the display by buffering character information from main memory and keeping track of the display position of the screen. The flexibility designed into the 8276H will allow simple interface to almost any raster scan CRT display. It can be used with the 8051 Single Chip Microcomputer for a minimum IC count design. It is manufactured on Intel's advanced HMOS-II process.

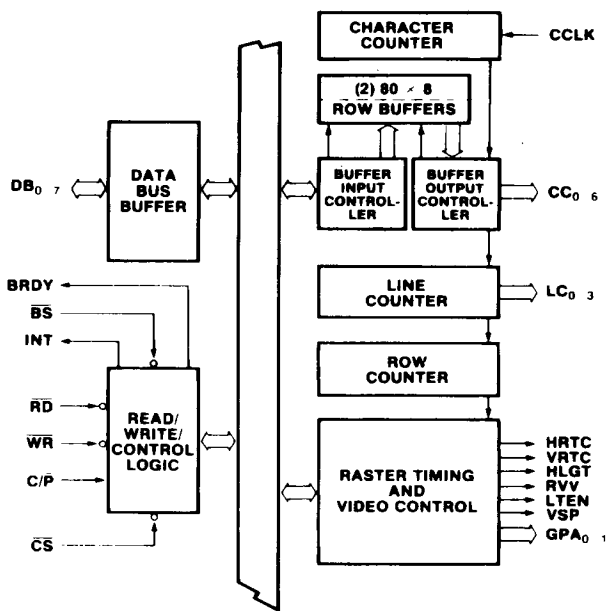

Figure 1. Block Diagram

210668-1

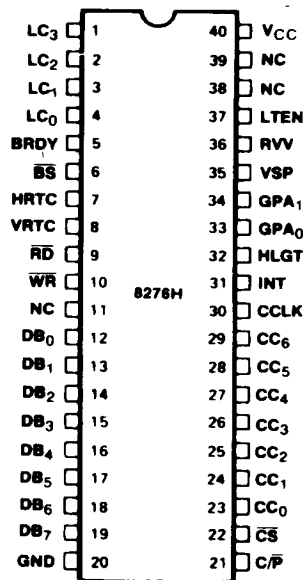

Figure 2. Pin configuration

210668-2

Table 1. Pin Descriptions

Symbol	Pin No.	Type	Name and Function
LC <sub>3</sub> LC <sub>2</sub> LC <sub>1</sub> LC <sub>0</sub>	1 2 3 4	O	<b>LINE COUNT:</b> Output from the line counter which is used to address the character generator for the line positions on the screen.
BRDY	5	O	<b>BUFFER READY:</b> Output signal indicating that a Row Buffer is ready for loading of character data.
$\overline{BS}$	6	I	<b>BUFFER SELECT:</b> Input signal enabling $\overline{WR}$ for character data into the Row Buffers.
HRTC	7	O	<b>HORIZONTAL RETRACE:</b> Output signal which is active during the programmed horizontal retrace interval. During this period the VSP output is high and the LTEN output is low.
VRTC	8	O	<b>VERTICAL RETRACE:</b> Output signal which is active during the programmed vertical retrace interval. During this period the VSP output is high and the LTEN output is low.
$\overline{RD}$	9	I	<b>READ INPUT:</b> A control signal to read registers.
$\overline{WR}$	10	I	<b>WRITE INPUT:</b> A control signal to write commands into the control registers or write data into the row buffers.
NC	11		<b>No Connection.</b>
DB <sub>0</sub> DB <sub>1</sub> DB <sub>2</sub> DB <sub>3</sub> DB <sub>4</sub> DB <sub>5</sub> DB <sub>6</sub> DB <sub>7</sub>	12 13 14 15 16 17 18 19	I/O	<b>BIDIRECTIONAL DATA BUS:</b> Three-state lines. The outputs are enabled during a read of the C or P ports.
Ground	20		<b>Ground.</b>
V <sub>CC</sub>	40		<b>+ 5V Power Supply.</b>
NC	39		<b>No Connection.</b>
NC	38		<b>No Connection.</b>
LTN	37	O	<b>LIGHT ENABLE:</b> Output signal used to enable the video signal to the CRT. This output is active at the programmed underline cursor position, and at positions specified by attribute codes.
RVV	36	O	<b>REVERSE VIDEO.</b> Output signal used to activate the CRT circuitry to reverse the video signal. This output is active at the cursor position if a reverse video block cursor is programmed or at the positions specified by the field attribute codes.
VSP	35	O	<b>VIDEO SUPPRESSION.</b> Output signal used to blank the video signal to the CRT. This output is active: —during the horizontal and vertical retrace intervals. —at the top and bottom lines of rows if underline is programmed to be number 8 or greater. —when an end of row or end of screen code is detected. —when a Row Buffer underrun occurs. —at regular intervals ( $1/16$ frame frequency for cursor, $1/32$ frame frequency for attributes)—to create blinking displays as specified by cursor or field attribute programming.
GPA <sub>1</sub> GPA <sub>0</sub>	34 33	O	<b>GENERAL PURPOSE ATTRIBUTE CODES:</b> Outputs which are enabled by the general purpose field attribute codes.
HLGT	32	O	<b>HIGHLIGHT:</b> Output signal used to intensify the display at particular positions on the screen as specified by the field attribute codes.
INT	31	O	<b>INTERRUPT OUTPUT.</b>
CCLK	30	I	<b>CHARACTER CLOCK:</b> (from dot/timing logic).

**Table 1. Pin Descriptions (Continued)**

Symbol	Pin No.	Type	Name and Function
CC <sub>6</sub> CC <sub>5</sub> CC <sub>4</sub> CC <sub>3</sub> CC <sub>2</sub> CC <sub>1</sub> CC <sub>0</sub>	29 28 27 26 25 24 23	O	<b>CHARACTER CODES:</b> Output from the row buffers used for character selection in the character generator.
$\overline{CS}$	22	I	<b>CHIP SELECT:</b> Enables $\overline{RD}$ of status or $\overline{WR}$ of command or parameters.
C/P	21	I	<b>PORT ADDRESS:</b> A high input on this pin selects the "C" port or command registers and a low input selects the "P" port or parameter registers.

## FUNCTIONAL DESCRIPTION

### Data Bus Buffer

This 3-state, bidirectional, 8-bit buffer is used to interface the 8276H to the system Data Bus.

This functional block accepts inputs from the System Control Bus and generates control signals for overall device operation. It contains the Command, Parameter, and Status Registers that store the various control formats for the device functional definition.

C/P	Operation	Register
0	Read	Reserved
0	Write	Parameter
1	Read	Status
1	Write	Command

### $\overline{RD}$ (READ)

A "low" on this input informs the 8276H that the CPU is reading status information from the 8276H.

### $\overline{WR}$ (WRITE)

A "low" on this input informs the 8276H that the CPU is writing data or control words to the 8276H.

### $\overline{CS}$ (CHIP SELECT)

A "low" on this input selects the 8276H for  $\overline{RD}$  or  $\overline{WR}$  of Commands, Status, and Parameters.

### BRDY (BUFFER READY)

A "high" on this output indicates that the 8276H is ready to receive character data.

### $\overline{BS}$ (BUFFER SELECT)

A "low" on this input enables  $\overline{WR}$  of character data to the 8276H row buffers.

### INT (INTERRUPT)

A "high" on this output informs the CPU that the 8276H needs interrupt service.

C/P	$\overline{RD}$	$\overline{WR}$	$\overline{CS}$	$\overline{BS}$	
0	0	1	0	1	Reserved
0	1	0	0	1	Write 8276H Parameter
1	0	1	0	1	Read 8276H Status
1	1	0	0	1	Write 8276H Command
X	1	0	1	0	Write 8276H Row Buffer
X	1	1	X	X	High Impedance
X	X	X	1	1	High Impedance

### Character Counter

The Character Counter is a programmable counter that is used to determine the number of characters to be displayed per row and the length of the horizontal retrace interval. It is driven by the CCLK (Character Clock) input, which should be derived from the external dot clock.

### Line Counter

The Line Counter is a programmable counter that is used to determine the number of horizontal lines (Raster Scans) per character row. Its outputs are used to address the external character generator.

### Row Counter

The Row Counter is a programmable counter that is used to determine the number of character rows to be displayed per frame and length of the vertical retrace interval.

### Raster Timing and Video Controls

The Raster Timing circuitry controls the timing of the HRTC (Horizontal Retrace) and VRTC (Vertical Retrace) outputs. The Video control circuitry controls the generation of HGLT (Highlight), RVV (Reverse Video), LTEN (Light Enable), VSP (Video Suppress), and GPA<sub>0-1</sub> (General Purpose Attribute) outputs.

### Row Buffers

The Row Buffers are two 80-character buffers. They are filled from the microcomputer system memory with the character codes to be displayed. While one row buffer is displaying a row of characters, the other is being filled with the next row of characters.

### Buffer Input/Output Controllers

The Buffer Input/Output Controllers decode the characters being placed in the row buffers. If the character is a field attribute or special code, they control the appropriate action. (Example: A "Highlight" field attribute will cause the Buffer Output Controller to activate the HGLT output.)

## SYSTEM OPERATION

The 8276H is programmable to a large number of different display formats. It provides raster timing,

display row buffering, visual attribute decoding and cursor timing.

It is designed to interface with standard character generators for dot matrix decoding. Dot level timing must be provided by external circuitry.

### General Systems Operational Description

Display characters are retrieved from memory and displayed on a row-by-row basis. The 8276H has two row buffers. While one row buffer is being used for display, the other is being filled with the next row of characters to be displayed. The number of display characters per row and the number of character rows per frame are software programmable, providing easy interface to most CRT displays. (See Programming Section.)

The 8276H uses BRDY to request character data to fill the row buffer that is not being used for display.

The 8276H displays character rows one scan line at a time. The number of scan lines per character row, the underline position, and blanking of top and bottom lines are programmable. (See Programming Section.)

The 8276H provides special Control Codes which can be used to minimize overhead. It also provides

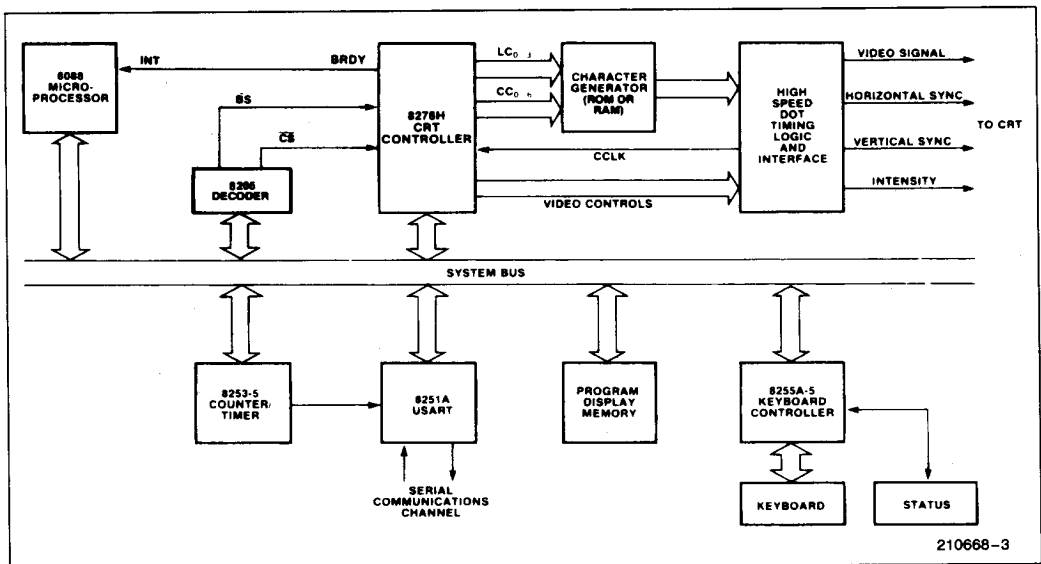

Figure 3. CRT System Block Diagram

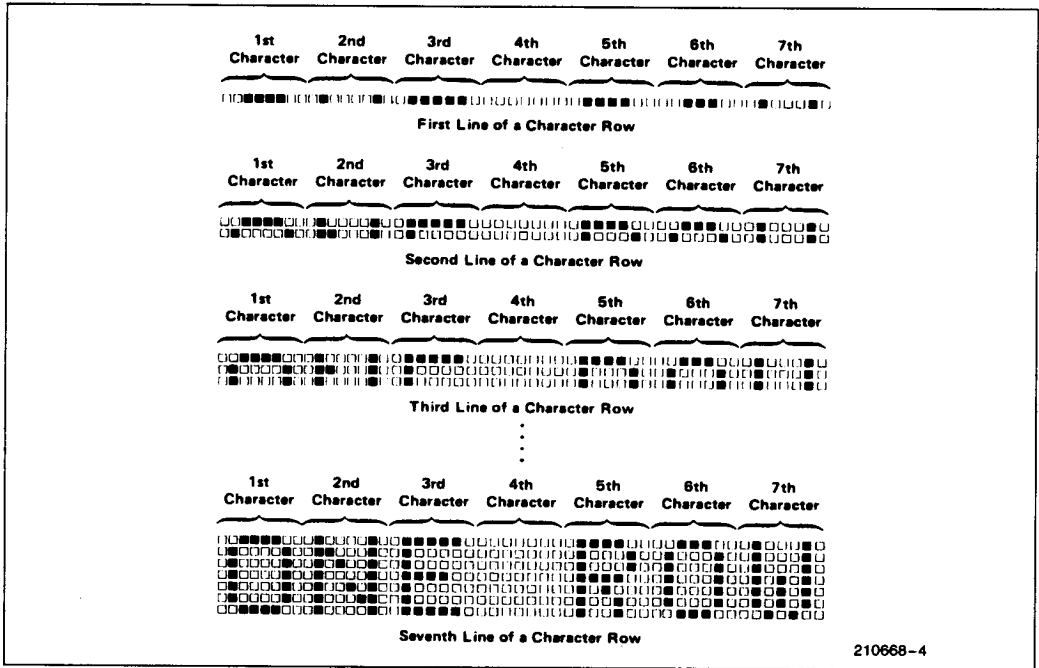

Figure 4. Display of A Character Row

210668-4

Visual Attribute Codes to cause special action on the screen without the use of the character generator. (See Visual Attributes Section.)

The 8276H also controls raster timing. This is done by generating Horizontal Retrace (HRTC) and Vertical Retrace (VRTC) signals. The timing of these signals is also programmable.

The 8276H can generate a cursor. Cursor location and format are programmable. (See Programming Section.)

This process is repeated until all of the character rows are displayed.

Row Buffering allows the CPU access to the display memory at all times except during Buffer Loading (about 25%). This compares favorably to alternative approaches which restrict CPU access to the display memory to occur only during horizontal and vertical retrace intervals (80% of the bus time is used to refresh the display).

### Display Row Buffering

Before the start of a frame, the 8276H uses BRDY and  $\overline{BS}$  to fill one row buffer with characters.

When the first horizontal sweep is started, character codes are output to the character generator from the row buffer just filled. Simultaneously, the other row buffer is filled with the next row of characters.

After all the lines of the character row are scanned, the buffers are swapped and the same procedure is followed for the next row.

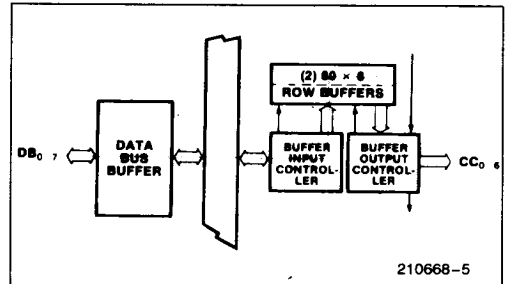

Figure 5. First Row Buffer Filled

210668-5

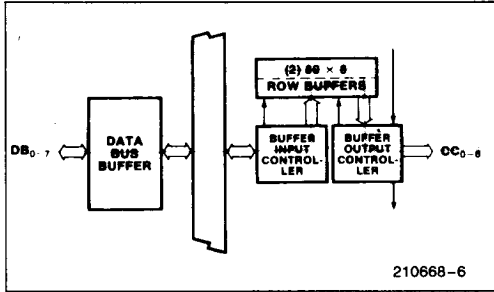

Figure 6. Second Row Buffer Filled, First Row Displayed

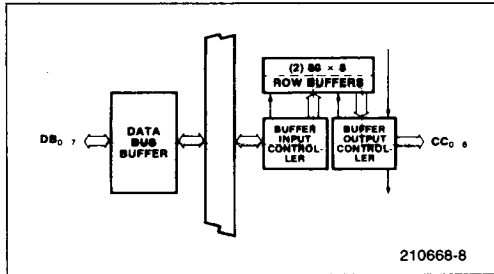

Figure 7. First Row Buffer Filled With Third Row, Second Row Displayed

Display Format

SCREEN FORMAT

The 8276H can be programmed to generate from 1 to 80 characters per row, and from 1 to 64 rows per frame.

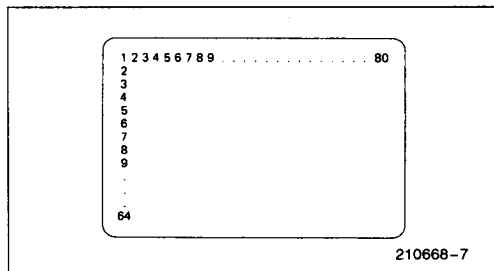

Figure 8. Screen Format

The 8276H can also be programmed to blank alternate rows. In this mode, the first row is displayed, the second blanked, the third displayed, etc. Display data is not requested for the blanked rows.

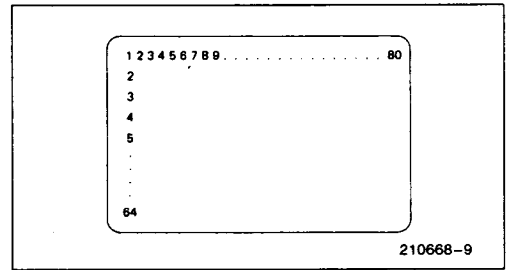

Figure 9. Blank Alternate Rows Mode

ROW FORMAT

The 8276H is designed to hold the line count stable while outputting the appropriate character codes during each horizontal sweep. The line count is incremented during horizontal retrace and the whole row of character codes are output again during the next sweep. This is continued until the entire character row is displayed.

The number of lines (horizontal sweeps) per character row is programmable from 1 to 16.

The output of the line counter can be programmed to be in one of two modes.

In mode 0, the output of the line counter is the same as the line number.

In mode 1, the line counter is offset by one from the line number.

NOTE:

In mode 1, while the first line (line number 0) is being displayed, the last count is output by the line counter (see examples).

Line Number	Line Counter Mode 0	Line Counter Mode 1
0	0000	1111
1	0001	0000
2	0010	0001
3	0011	0010
4	0100	0011
5	0101	0100
6	0110	0101
7	0111	0110
8	1000	0111
9	1001	1000
10	1010	1001
11	1011	1010
12	1100	1011
13	1101	1100
14	1110	1101
15	1111	1110

210668-10

Figure 10. Example of a 16-Line Format

Line Number	Line Counter Mode 0	Line Counter Mode 1
0	0000	1001
1	0001	0000
2	0010	0001
3	0011	0010
4	0100	0011
5	0101	0100
6	0110	0101
7	0111	0110
8	1000	0111
9	1001	1000

210668-12

Figure 11. Example of a 10-Line Format

Mode 0 is useful for character generators that leave address zero blank and start at address 1. Mode 1 is useful for character generators which start at address zero.

Underline placement is also programmable (from line number 0 to 15). This is independent of the line counter mode.

If the line number of the underline is greater than 7 (line number MSB = 1), then the top and bottom lines will be blanked.

Line Number	Line Counter Mode 0	Line Counter Mode 1
0	0000	1011
1	0001	0001
2	0010	0001
3	0011	0011
4	0100	0011
5	0101	0100
6	0110	0101
7	0111	0110
8	1000	0111
9	1001	1000
10	1010	1001
11	1011	1010

210668-11

Top and Bottom Lines are Blanked

Figure 12. Underline in Line Number 10

If the line number of the underline is less than or equal to 7 (line number MSB = 0), then the top and bottom lines will not be blanked.

Line Number	Line Counter Mode 0	Line Counter Mode 1
0	0000	0111
1	0001	0000
2	0010	0001
3	0011	0010
4	0100	0011
5	0101	0100
6	0110	0101
7	0111	0110

210668-13

Top and Bottom Lines are not Blanked

Figure 13. Underline in Line Number 7

If the line number of the underline is greater than the maximum number of lines, the underline will not appear.

Blanking is accomplished by the VSP (Video Suppression) signal. Underline is accomplished by the LTEN (Light Enable) signal.

**DOT FORMAT**

Dot width and character width are dependent upon the external timing and control circuitry.

Dot level timing circuitry should be designed to accept the parallel output of the character generator and shift it out serially at the rate required by the CRT display.

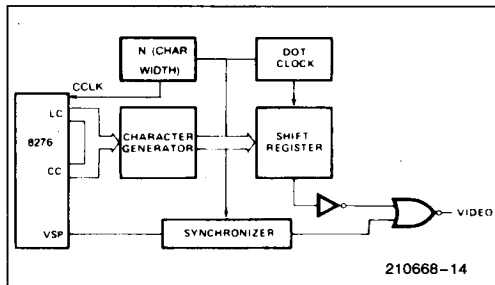

Figure 14. Typical Dot Level Block Diagram

Dot width is a function of dot clock frequency.

Character width is a function of the character generator width.

Horizontal character spacing is a function of the shift register length.

**NOTE:**

Video control and timing signals must be synchronized with the video signal due to the character generator access delay.

**Raster Timing**

The character counter is driven by the character clock input (CCLK). It counts out the characters being displayed (programmable from 1 to 80). It then causes the line counter to increment, and it starts counting out the horizontal retrace interval (programmable from 2 to 32). This process is constantly repeated.

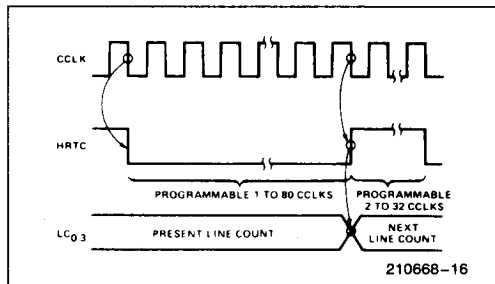

Figure 15. Line Timing

The line counter is driven by the character counter. It is used to generate the line address outputs (LC<sub>0-3</sub>) for the character generator. After it counts all of the lines in a character row (programmable from 1 to 16), it increments the row counter, and starts over again. (See Character Format Section for detailed description of Line Counter functions.)

The row counter is an internal counter driven by the line counter. It controls the functions of the row buffers and counts the number of character rows displayed.

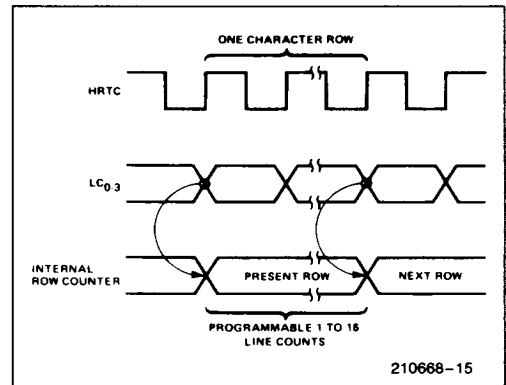

Figure 16. Row Timing

After the row counter counts all of the rows in a frame (programmable from 1 to 64), it starts counting out the vertical retrace interval (programmable from 1 to 4).

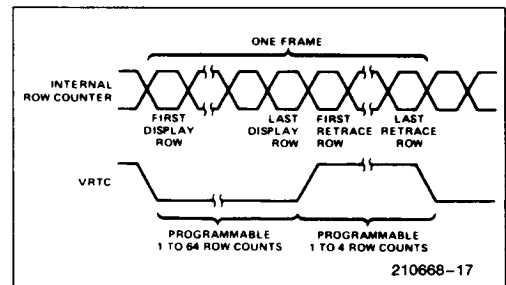

Figure 17. Frame Timing

The Video Suppression Output (VSP) is active during horizontal and vertical retrace intervals.

Dot level timing circuitry must synchronize these outputs with the video signal to the CRT Display.

**Interrupt Timing**

The 8276H can be programmed to generate an interrupt request at the end of each frame. If the 8276H interrupt enable flag is set, an interrupt request will occur at the *beginning* of the *last display row*.

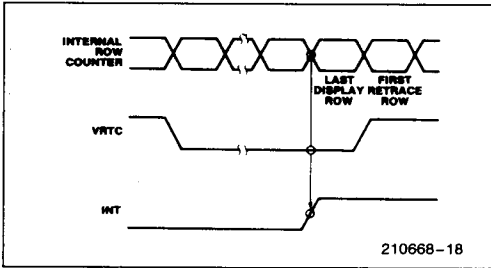

**Figure 18. Beginning of Interrupt**

INT will go inactive after the status register is read.

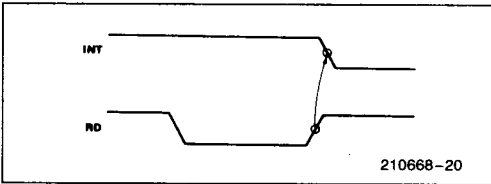

**Figure 19. End of Interrupt**

A reset command will also cause INT to go inactive, but this is not recommended during normal service.

**NOTE:**

Upon power-up, the 8276H Interrupt Enable Flag may be set. As a result, the user's cold start routine should write a reset command to the 8276H before system interrupts are enabled.

**VISUAL ATTRIBUTES AND SPECIAL CODES**

The characters processed by the 8276H are 8-bit quantities. The character code outputs provide the character generator with 7 bits of address. The Most Significant Bit is the extra bit and it is used to determine if it is a normal display character (MSB = 0), or if it is a Field Attribute or Special Code (MSB = 1).

**Special Codes**

Four special codes are available to help reduce bus usage.

**SPECIAL CONTROL CHARACTER**

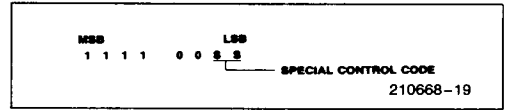

S	S	Function
0	0	End of Row
0	1	End of Row-Stop Buffer Loading
1	0	End of Screen
1	1	End of Screen-Stop Buffer Loading

The End of Row Code (00) activates VSP and holds it to the end of the line.

The End of Row-Stop Buffer Loading (BRADY) Code (01) causes the Buffer Loading Control Logic to stop buffer loading for the rest of the row upon being written into the Row Buffer. It affects the display in the same way as the End of Row Code (00).

The End of Screen Code (10) activates VSP and holds it to the end of the frame.

The End of Screen-Stop Buffer Loading (BRDY) Code (11) causes the Row Buffer Control Logic to stop buffer loading for the rest of the frame upon being written. It affects the display in the same way as the End of Screen Code (10).

If the Stop Buffer Loading feature is not used, all characters after an End of Row character are ignored, except for the End of Screen character, which operates normally. All characters after an End of Screen character, are ignored.

**NOTE:**

If a Stop Buffer Loading is not the last character in a row, Buffer Loading is not stopped until after the next character is read. In this situation, a dummy character must be placed in memory after the Stop Buffer Loading character.

**Field Attributes**

The field attributes are control codes which affect the visual characteristics for a field of characters, starting at the character following the code up to, and including, the character which precedes the *next* field attribute code, or up to the end of the frame. The field attributes are reset during the vertical retrace interval.

The 8276H can be programmed to provide visible field attribute characters; all field attribute codes will occupy a position on the screen. These codes will appear as blanks caused by activation of the Video Suppression output (VSP). The chosen visual attributes are activated after this blanked character.

There are six field attributes:

- 1) *Blink*—Characters following the code are caused to blink by activating the Video Suppression output (VSP). The blink frequency is equal to the screen refresh frequency divided by 32.
- 2) *Highlight*—Characters following the code are caused to be highlighted by activating the Highlight output (HGLT).
- 3) *Reverse Video*—Characters following the code are caused to appear with reverse video by activating the Reverse Video output (RVV).
- 4) *Underline*—Characters following the code are caused to be underlined by activating the Light Enable output (LTEN).
- 5, 6) *General Purpose*—There are two additional 8276H outputs which act as general purpose, independently programmable field attributes.  $GPA_{0-1}$  are active high outputs.

- H = 1 FOR HIGHLIGHTING**
- B = 1 FOR BLINKING**
- R = 1 FOR REVERSE VIDEO**
- U = 1 FOR UNDERLINE**
- GG = 1 FOR  $GPA_1, GPA_0$**

**NOTE:**

More than one attribute can be enabled at the same time. If the blinking and reverse video attributes are enabled simultaneously, only the reversed characters will blink.

**Cursor Timing**

The cursor location is determined by a cursor row register and a character position register which are loaded by command to the controller. The cursor can be programmed to appear on the display as:

1. a blinking underline
2. a blinking reverse video block
3. a non-blinking underline
4. a non-blinking reverse video block

The cursor blinking frequency is equal to the screen refresh frequency divided by 16.

If a non-blinking reverse video *cursor* appears in a non-blinking reverse video *field*, the cursor will appear as a normal video block.

If a non-blinking underline *cursor* appears in a non-blinking underline *field*, the cursor will not be visible.

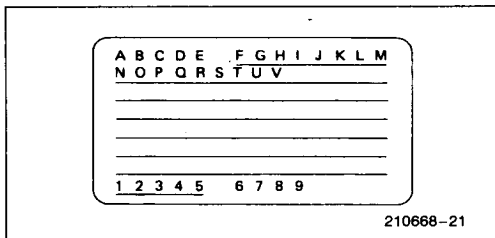
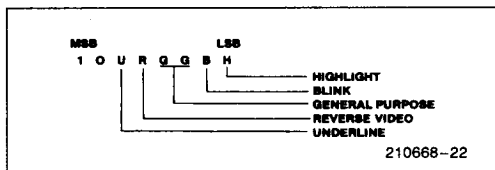

Figure 20. Example of a Visible Field Attribute (Underline Attribute)

**FIELD ATTRIBUTE CODE**



**Device Programming**

The 8276H has two programming registers, the Command Register and the Parameter Register. It also has a Status Register. The Command Register can only be written into and the Status Register can only be read from. They are addressed as follows:

C/P	Operation	Register
0	Read	Reserved
0	Write	Parameter
1	Read	Status
1	Write	Command

The 8276H expects to receive a command and a sequence of 0 to 4 parameters, depending on the command. If the proper number of parameter bytes are not received before another command is given, a status flag is set, indicating an improper command.

**Instruction Set**

The 8276H instruction set consists of 7 commands

Command	No. of Parameter Bytes
Reset	4
Start Display	0
Stop Display	0
Load Cursor	2
Enable Interrupt	0
Disable Interrupt	0
Preset Counters	0

In addition, the status of the 8276H can be read by the CPU at any time.

**1. RESET COMMAND**

Command	Operation	C/P	Description	Data Bus							
				MSB	LSB						
Parameters	Write	1	Reset Command	0	0	0	0	0	0	0	0
	Write	0	Screen Comp Byte 1	S	H	H	H	H	H	H	H
	Write	0	Screen Comp Byte 2	V	V	R	R	R	R	R	R
	Write	0	Screen Comp Byte 3	U	U	U	L	L	L	L	L
	Write	0	Screen Comp Byte 4	M	1	C	C	Z	Z	Z	Z

**Action**—After the reset command is written, BRDY goes inactive, 8276H interrupts are disabled, and the VSP output is used to blank the screen. HRTC and VRTC continue to run. HRTC and VRTC timing are random on power-up.

As parameters are written, the screen composition is defined.

**Parameter—S Spaced Rows**

S	Functions
0	Normal Rows
1	Spaced Rows

**Parameter—HHHHHHH Horizontal Characters/Row**

H	H	H	H	H	H	H	No. Of Characters Per Row
0	0	0	0	0	0	0	1
0	0	0	0	0	0	1	2
0	0	0	0	0	1	0	3
			•				•
			•				•
			•				•
1	0	0	1	1	1	1	80
1	0	1	0	0	0	0	Undefined
			•				•
			•				•
			•				•
1	1	1	1	1	1	1	Undefined

**Parameter—VV Vertical Retrace Row Count**

V	V	No. Of Row Counts Per VRTC
0	0	1
0	1	2
1	0	3
1	1	4

**Parameter—RRRRRR Vertical Rows/Frame**

R	R	R	R	R	R	No. Of Rows/Frame
0	0	0	0	0	0	1
0	0	0	0	0	1	2
0	0	0	0	1	0	3
			•			•
			•			•
			•			•
1	1	1	1	1	1	64

**Parameter—UUUU Underline Placement**

U	U	U	U	Line Number Of Underline
0	0	0	0	1
0	0	0	1	2
0	0	1	0	3
			•	•
			•	•
			•	•
1	1	1	1	16

**Parameter—LLLL Number of Lines Per Character Row**

L	L	L	L	No. Of Lines/Row
0	0	0	0	1
0	0	0	1	2
0	0	1	0	3
			•	•
			•	•
			•	•
1	1	1	1	16

**Parameter—M Line Counter Mode**

M	Line Counter Mode
0	Mode 0 (Non-Offset)
1	Mode 1 (Offset by 1 Count)

**Parameter—CC Cursor Format**

C	C	Cursor Format
0	0	Blinking Reverse Video Block
0	1	Blinking Underline
1	0	Non-blinking Reverse Video Block
1	1	Non-blinking Underline

**Parameter—ZZZZ Horizontal Retrace Count**

Z	Z	Z	Z	No. Of Character Counts Per HRTC
0	0	0	0	2
0	0	0	1	4
0	0	1	0	6
.	.	.	.	.
.	.	.	.	.
1	1	1	1	32

**NOTE:**

uuuu MSB determines blanking of top and bottom lines (1 = blanked, 0 = not blanked).

**2. START DISPLAY COMMAND**

	Operation	C/P	Description	Data Bus MSB	LSB
Command	Write	1	Start Display	0	0 1 0 0 0 0 0 0
No Parameters					

**Action**—8276H interrupts are enabled, BRDY goes active, video is enabled, Interrupt Enable and Video Enable status flags are set.

**3. STOP DISPLAY COMMAND**

	Operation	C/P	Description	Data Bus MSB	LSB
Command	Write	1	Stop Display	0	1 0 0 0 0 0 0 0
No Parameters					

**Action**—Disables video, interrupts remain enabled, HRTC and VRTC continue to run, Video Enable status flag is reset, and the "Start Display" command must be given to reenables the display.

**4. LOAD CURSOR POSITION**

	Operation	C/P	Description	Data Bus MSB	LSB
Command	Write	1	Load Cursor	1	0 0 0 0 0 0 0 0
Parameters	Write	0	Char. Number	(Char. Position in Row)	(Row Number)
	Write	0	Row Number		

**Action**—The 8276H is conditioned to place the next two parameter bytes into the cursor position registers. Status flag not affected.

**5. ENABLE INTERRUPT COMMAND**

	Operation	C/P	Description	Data Bus MSB	LSB
Command	Write	1	Enable Interrupt	1	0 1 0 0 0 0 0 0
No Parameters					

**Action**—The interrupt enable flag is set and interrupts are enabled.

**6. DISABLE INTERRUPT COMMAND**

	Operation	C/P	Description	Data Bus MSB	LSB
Command	Write	1	Disable Interrupt	1	0 1 0 0 0 0 0 0
No Parameters					

**Action**—Interrupts are disabled and the interrupt enable status flag is reset.

**7. PRESET COUNTERS COMMAND**

	Operation	C/P	Description	Data Bus MSB	LSB
Command	Write	1	Preset Counters	1	1 1 0 0 0 0 0 0
No Parameters					

**Action**—The internal timing counters are preset, corresponding to a screen display position at the top left corner. Two character clocks are required for this operation. The counters will remain in this state until any other command is given.

This command is useful for system debug and synchronization of clustered CRT displays on a single CPU. After this command, two additional clock cycles are required before the first character of the first row is put out.

**Status Flags**

	Operation	C/P	Description	Data Bus MSB	LSB
Command	Read	1	Status Word	0	IE IR X IC VE BU X

- IE — (Interrupt Enable) Set or reset by command. It enables vertical retrace interrupt. It is automatically set by a "Start Display" command and reset with the "Reset" command.
- IR — (Interrupt Request) This flag is set at the beginning of display of the last row of the frame if the interrupt enable flag is set. It is reset after a status read operation.
- IC — (Improper Command) This flag is set when a command parameter string is too long or too short. The flag is automatically reset after a status read.
- VE — (Video Enable) This flag indicates that video operation of the CRT is enabled. This flag is set on a "Start Display" command, and reset on a "Stop Display" or "Reset" command.
- BU — (Buffer Underrun) This flag is set whenever a Row Buffer is not filled with character data in time for a buffer swap required by the display. Upon activation of this bit, buffer loading ceases, and the screen is blanked until after vertical retrace interval.

**ABSOLUTE MAXIMUM RATINGS\***

Ambient Temperature Under Bias ..... 0°C to 70°C  
 Storage Temperature ..... -65°C to +150°C  
 Voltage On Any Pin  
     With Respect to Ground ..... -0.5V to +7V  
 Power Dissipation ..... 1 Watt

*\*Notice: Stresses above those listed under "Absolute Maximum Ratings" may cause permanent damage to the device. This is a stress rating only and functional operation of the device at these or any other conditions above those indicated in the operational sections of this specification is not implied. Exposure to absolute maximum rating conditions for extended periods may affect device reliability.*

**D.C. CHARACTERISTICS**  $T_A = 0^\circ\text{C to } 70^\circ\text{C}; V_{CC} = 5V \pm 5\%$

Symbol	Parameter	Min	Max	Units	Test Conditions
$V_{IL}$	Input Low Voltage	-0.5	0.8	V	
$V_{IH}$	Input High Voltage	2.0	$V_{CC} + 0.5V$	V	
$V_{OL}$	Output Low Voltage		0.45	V	$I_{OL} = 2.2 \text{ mA}$
$V_{OH}$	Output High Voltage	2.4		V	$I_{OH} = -400 \mu\text{A}$
$I_{IL}$	Input Load Current		$\pm 10$	$\mu\text{A}$	$V_{IN} = V_{CC} \text{ to } 0V$
$I_{OFL}$	Output Float Leakage		$\pm 10$	$\mu\text{A}$	$V_{OUT} = V_{CC} \text{ to } 0.45V$
$I_{CC}$	$V_{CC}$ Supply Current		160	mA	

**CAPACITANCE**  $T_A = 25^\circ\text{C}; V_{CC} = 25^\circ\text{C}; V_{CC} = \text{GND} = 0V$

Symbol	Parameter	Min	Max	Units	Test Conditions
$C_{IN}$	Input Capacitance		10	pF	$f_c = 1 \text{ MHz}$ Unmeasured pins returned to $V_{SS}$ .
$C_{I/O}$	I/O Capacitance		20	pF	

**A.C. TESTING LOAD CIRCUIT**

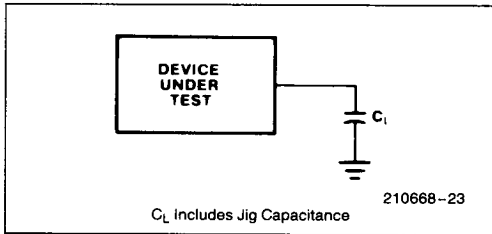

**A.C. CHARACTERISTICS**  $T_A = 0^\circ\text{C to } 70^\circ\text{C}; V_{CC} = 5.0\text{V} \pm 5\%; \text{GND} = 0\text{V}$ 
**Bus Parameters**
**READ CYCLE**

Symbol	Parameter	Min	Max	Units	Test Conditions
$t_{AR}$	Address Stable Before READ	0		ns	
$t_{RA}$	Address Hold Time for READ	0		ns	
$t_{RR}$	READ Pulse Width	250		ns	
$t_{RD}$	Data Delay from READ		200	ns	$C_L = 150 \text{ pF}$
$t_{DF}$	READ to Data Floating		100	ns	

**WRITE CYCLE**

Symbol	Parameter	Min	Max	Units	Test Conditions
$t_{AW}$	Address Stable Before WRITE	0		ns	
$t_{WA}$	Address Hold Time for WRITE	0		ns	
$t_{WW}$	WRITE Pulse Width	250		ns	
$t_{DW}$	Data Setup Time for WRITE	150		ns	
$t_{WD}$	Data Hold Time for WRITE	0		ns	

**CLOCK TIMING**

Symbol	Parameter	8276H		8276-2		Units	Test Conditions
		Min	Max	Min	Max		
$t_{CLK}$	Clock Period	480		320		ns	
$t_{KH}$	Clock High	240		120		ns	
$t_{KL}$	Clock Low	160		120		ns	
$t_{KR}$	Clock Rise	5	30	5	30	ns	
$t_{KF}$	Clock Fall	5	30	5	30	ns	

**OTHER TIMING**

Symbol	Parameter	8276H		8276-2		Units	Test Conditions
		Min	Max	Min	Max		
$t_{CC}$	Character Code Output Delay		150		150	ns	$CL = 50 \text{ pF}$
$t_{HR}$	Horizontal Retrace Output Delay		200		150	ns	$CL = 50 \text{ pF}$
$t_{LC}$	Line Count Output Delay		400		250	ns	$CL = 50 \text{ pF}$
$t_{AT}$	Control/Attribute Output Delay		275		250	ns	$CL = 50 \text{ pF}$
$t_{VR}$	Vertical Retrace Output Delay		275		250	ns	$CL = 50 \text{ pF}$
$t_{RI}$	$\text{INT} \downarrow$ from $\text{RD} \uparrow$		250		250	ns	$CL = 50 \text{ pF}$
$t_{WQ}$	$\text{BRDY} \uparrow$ from $\text{WR} \uparrow$		250		250	ns	$CL = 50 \text{ pF}$
$t_{RQ}$	$\text{BRDY} \downarrow$ from $\text{WR} \downarrow$		200		200	ns	$CL = 50 \text{ pF}$
$t_{LR}$	$\overline{\text{BS}} \downarrow$ to $\text{WR} \downarrow$	0		0		ns	
$t_{RL}$	$\overline{\text{WR}} \uparrow$ to $\text{BS} \uparrow$	0		0		ns	

WAVEFORMS

TYPICAL DOT LEVEL TIMING

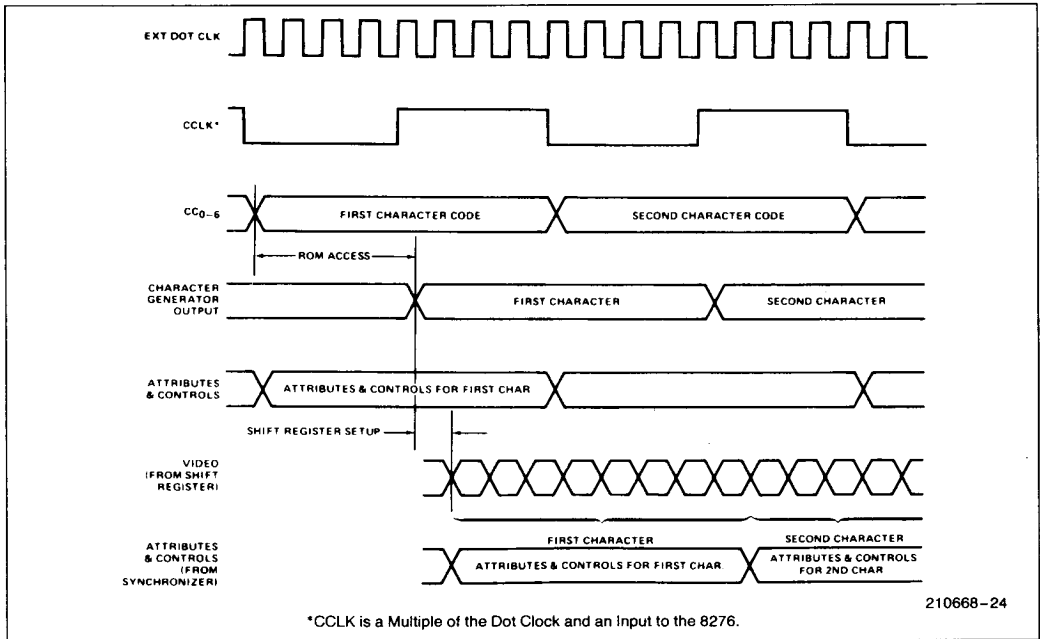

LINE TIMING

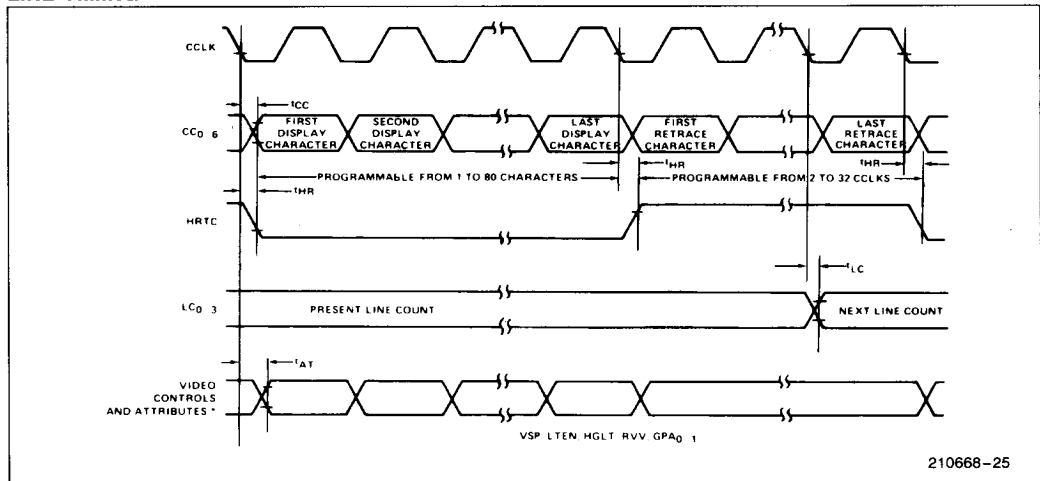

ROW TIMING

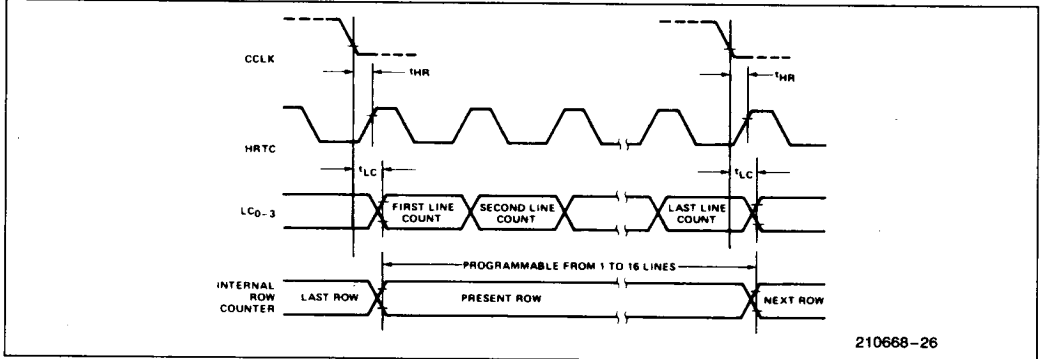

FRAME TIMING

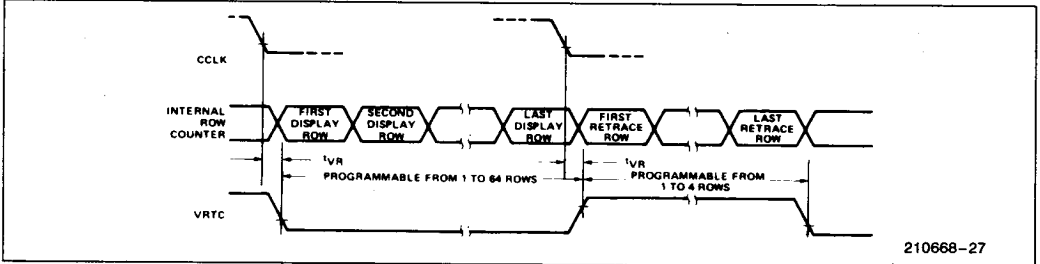

INTERRUPT TIMING

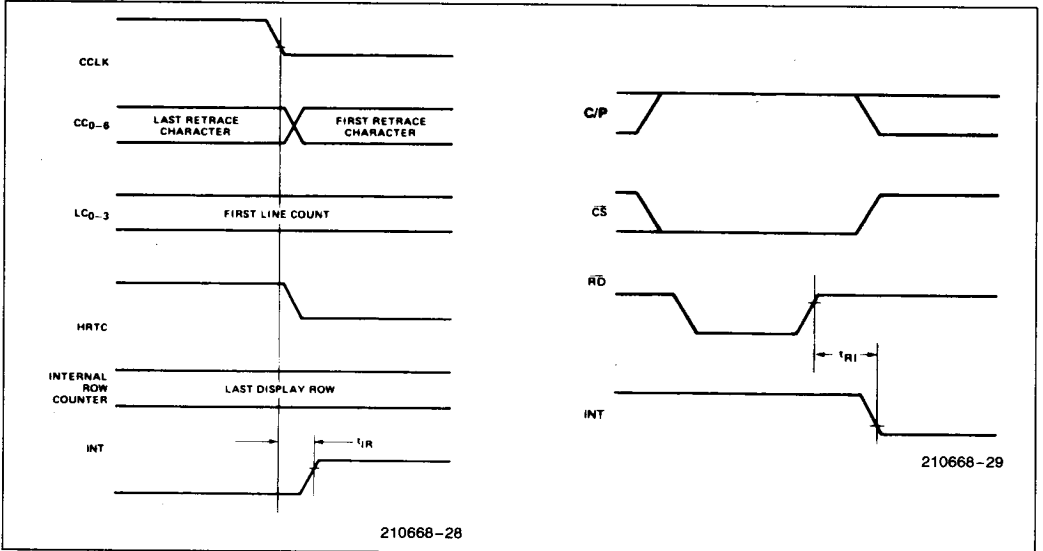

**TIMING FOR BUFFER LOADING**

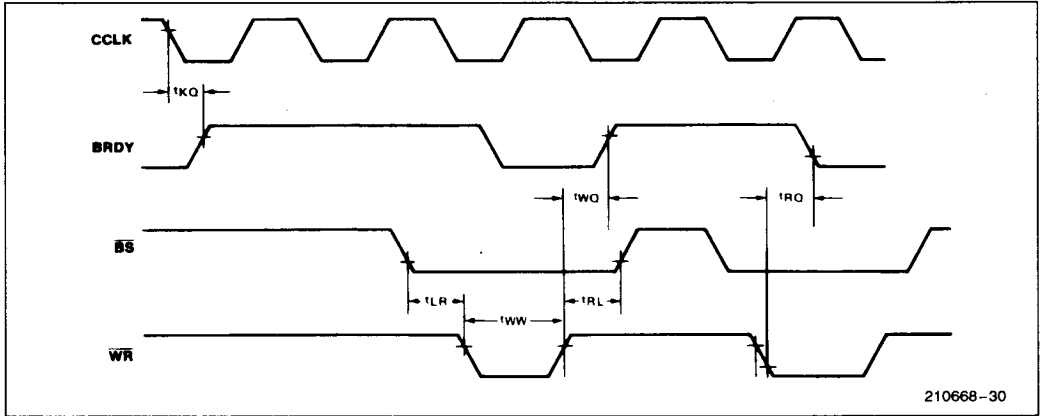

**WRITE TIMING**

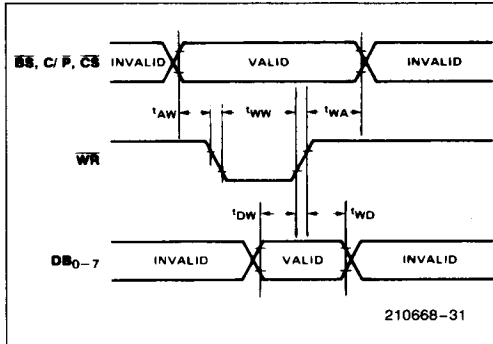

**READ TIMING**

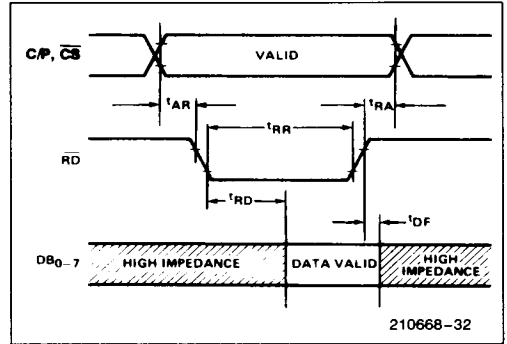

**CLOCK TIMING**

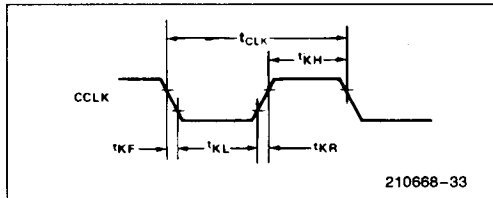

**INPUT AND OUTPUT WAVEFORMS FOR A.C. TESTS**

